

Motorcycle Batteries



intAct Bike-Power AGM

Sealed AGM battery (electrolyte held in Absorbent Glass Mat separators) | dry-charged, acid pack is included | maintenance-free after initial filling



AFFORDABLE ALL-ROUNDER

Withstands the frequent charging cycles in seasonal use and on many short trips slightly better than conventional flooded batteries and starts reliably even when not fully charged. Our recommendation for anybody in need of an affordable sealed motorcycle battery.

- » **High power reserve.** Significant starting power even when partially discharged.
- » **Shake-proof.** The plates are firmly embedded in the glass fibre mat.
- » **Maintenance-free after initial filling by a specialist dealer or workshop.** Refilling is then no longer possible and not necessary, because the then sealed battery loses virtually no liquid due to gas recombination.
- » **Not well suited for repeated deep discharging** (below 10.5 volts).
- » The battery can also be installed at an angle, as the electrolyte is held in the glass fiber mat and the battery is tightly sealed after filling.

Datasheet

BIKE
POWER **AGM**

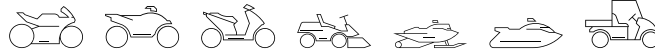

Artnum.

IA YTX116-BS

Japan-Code

CTX16-BS

Volt

12V

Capacity

14 AH (c20)

CCR - 18°C (EN)

220 A (EN)

Electrolyte

diluted sulphuric acid

Electrolyte density

1,32 +/- 0,01 kg/l (25°)

Size (LxWxH)

150 x 87 x 160 mm

Weight

5,2 kg

Pos. of Terminal

1

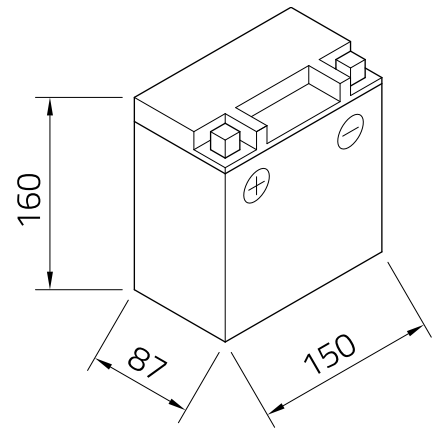
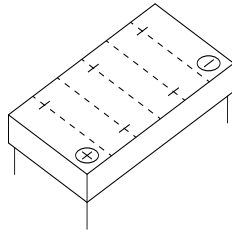

Technology

Sealed AGM battery (electrolyte held in Absorbent Glass Mat separators) | dry-charged, acid pack is included | maintenance-free after initial filling

Terminal

A

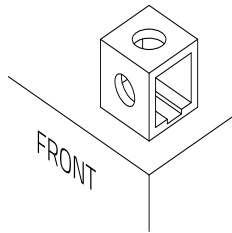

Base plate

-

LANDPORT
BATTERIES

Landport Batteries
Ramgatseweg 63
4941VN Raamsdonksveer

+31 (0) 162 58 14 00
www.landportbv.com