

Motorcycle Batteries

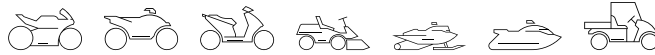

intAct Bike-Power GEL

Sealed maintenance-free GEL battery | electrolyte immobilized by gel-additive | wet charged



FOR HEAVY LOADS, INCLUDING ABS

Delivers 30% more starting power for modern motorcycles with many electrical consumers and covers consumption peaks. Low self-discharge, bike starts reliably even after up to 3 months. Our recommendation if many consumers are installed or the motorcycle is rarely used.

- » **Even more cycle-resistant** than Bike-Power AGM and Bike-Power SLA of the same box size.
- » **Low self-discharge.** For seasonal use.
- » **Very high vibration-resistance.** Electrolyte immobilized by gel-additive.
- » **30% more starting power** than a conventional battery of the same box size. For motorcycles with many consumers, including ABS.
- » **Sealed maintenance-free** battery. Refilling is neither possible nor necessary.
- » Wet charged. **Ready to use.**

Datasheet



Artnum.	IG YTX5L-BS
Japan-Code	CTX5L-BS, 50412
Volt	12V
Capacity	4 AH (c20)
CCR - 18°C (EN)	70 A (EN)
Electrolyte	diluted sulphuric acid
Electrolyte density	1,28 +/- 0,01 kg/l (25°)
Size (LxWxH)	113 x 70 x 105 mm
Weight	2,2 kg
Pos. of Terminal	0

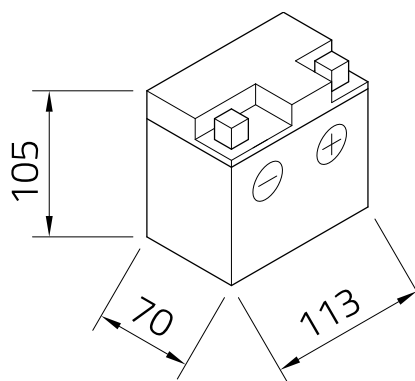
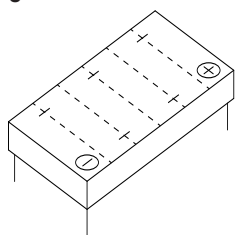

Technology Sealed maintenance-free GEL battery | electrolyte immobilized by gel-additive | wet charged

Terminal A

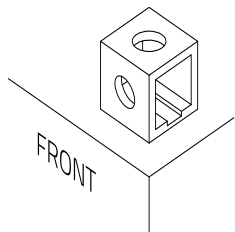

Base plate -